

XIANGSAI

China ceiling manufacturing

base in Guangdong, China. 100% factory direct

Surface Treatment

表面处理工艺

Powder-painting

Smooth surface, fine, strong adhesion, weathering acid and alkali, anti-ultraviolet anti-decay, suitable for indoor and outdoor space for ornaments.

Viscosity	70.0
Density	9.9
Luster	30.00
Fineness	5.5min
Adhesion	pass

喷粉

表面光滑细腻, 附着力强, 耐候耐酸碱, 抗紫外线防衰变, 适用于室内室外空间的装饰。

粘度	70.0
密度	9.9
光泽	30.00
细度	5.5min
附着力	pass

Oil-painting

Gloss is good, has good adhesion, weather resistance and oil resistance. Scrub, anti-ultraviolet strong, suitable for indoor and outdoor space for ornaments.

Viscosity	75.0
Density	9.9
Luster	32.00
Fineness	5.5min
Adhesion	pass

喷漆

光泽度好, 具有良好的附着力、耐候性和耐油性, 耐擦洗, 抗紫外线强, 适用于室内室外空间的装饰。

粘度	75.0
密度	9.9
光泽	32.00
细度	5.5min
附着力	pass

Polyester Oil-painting

Smooth surface, fine, good adhesion, flame-retardant coefficient high, not easy to change color, under normal circumstances, an indoor installation of 15-20 years can guarantee that the color change.

Viscosity	75.0
Density	10.03
Luster	32.00
Fineness	5.5min
Adhesion	pass

喷聚酯漆

表面光滑细腻, 粘合力好, 阻燃系数高, 不易变色, 在正常情况下, 室内安装可保证颜色15-20年不变。

粘度	75.0
密度	10.03
光泽	32.00
细度	5.5min
附着力	pass

Fluorocarbon Oil-painting

Fine powder, gloss is good, strong adhesion. Matt states, giving comfort, high-grade feeling. Resistance to wind, rain, sun, used for outdoor decoration.

Viscosity	70.0
Density	9.9
Luster	28.00
Fineness	5.5min
Adhesion	pass

喷氟碳漆

粉末细腻, 光泽度好, 附着力强。哑光状态, 给人舒适、高档的感觉。耐风、雨、日晒, 多用于室外装修。

粘度	70.0
密度	9.9
光泽	28.00
细度	5.5min
附着力	pass



Punch Patterns 冲孔花款

Pattern 孔型	Base Thickness (mm) 底板厚度 (mm)
1.8 pore 微孔	0.45-0.8
2.0 straight line of holes 直排孔	0.45-1.0
2.3 pore 微孔	0.45-0.8
2.5 pore 微孔	0.45-0.8
3 PCT square hole 厘方孔	0.45-0.8
5 PCT square hole 厘方孔	0.45-0.9
6 PCT hole 厘圆孔	0.45-1.0
6 PCT square hole 厘方孔	0.45-0.8
Diagonal 对角	0.45-0.7
Full bore 全孔	0.45-0.8



BDS A01 平面



BDS A02(Φ3) 对角

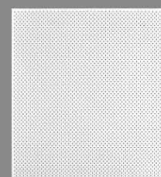

BDS A03(Φ3) 全孔



BDS A06(Φ3) 四方对角

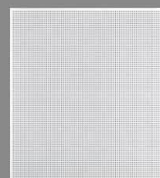

BDS A07(Φ2) 直排也

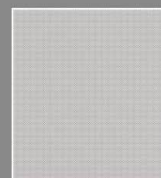

BDS A05(Φ1.8) 微孔

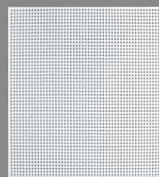

BDS A36(Φ6) 大孔



BDS A45(Φ2.3) 凹形

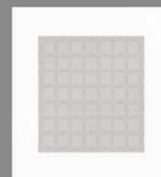

BDS A46(Φ2.3) 中间冲孔

Punching patch is divided into 冲孔贴布分为

Black cloth:

13% noise reduction effect

Fire performance:

Meet national GB8624-retardant B1 level.

黑布: 13% 降噪效果

防火性能: 达到国家GB8624-难燃B1级

White cloth:

11% silencing effect of noise reduction

Fire performance:

meet national GB8624-retardant B1 level.

白布: 11% 降噪消音效果

防火性能: 达到国家GB8624-难燃B1级

Fire acoustic paper:

19% noise reduction effect of silencing

Fire Performance:

Meet national GB8624-retardant B1 level.

防火吸声纸: 19% 降噪消音效果

防火性能: 达到国家GB8624-难燃B1级

Import sound-absorbing fabric:

22% noise reduction effect of silencing

Fire Performance:

Meet national GB8624-retardant B1 level.

进口吸音布: 22% 降噪消音效果

防火性能: 达到国家GB8624-难燃B1级



SQUARE CEILING SERIES INVISIBLE FRAME TYPE (CLIP-IN)

暗架式方板吊顶系列

Features Description

特点说明

Invisible frame type ceiling, its own unique product structure, installation hanger hidden, visual effects, fluid formation and affected by many customers. Invisible frame type ceiling series can produce a variety of specifications and the specifications under the hem of each type of edge can be divided into short right-angle, short bevel angle, high-side right-angle, high-side angle. Among them, short edge series can save you more space, while the high-side series is more stable and stronger. If sound-absorbing function is needed, Invisible has more than 30 kinds of punching Patterns to choose from. Installation structure, simple and secure, hidden hanger; the upper 38 main tee and the lower triangular keel-shaped structure with a strong combination of wells, installation and removal easy, the surface is very smooth. Scope of application: home of the kitchen, toilet, bedroom, living room and even larger places such as hotels, shops, offices, hospitals, etc.,

暗架式方板吊顶, 因其产品自身独特的构造, 安装后吊架隐藏, 因视觉效果大气、流畅平整而受众多客户青睐。暗架式方板吊顶系列可生产多种规格, 且每种规格根据折边类型可分为矮边直角、矮边斜角、高边直角、高边斜角。其中, 矮边系列可以节省更多的空间, 而高边系列则更加平稳坚固。同时, 暗架式具备30多种冲孔花款可供选择, 不仅可以起到美观装饰的效果, 还能够通过吸音布起到消音降噪的实用功能。

Scope of application

适用范围

larger public buildings, such as: airports, train stations, subway stations.
 大型之厨房、洗手间、卧室、客厅甚至面积较大的场所, 如宾馆、商店、办公室、医院等。

Invisible frame type ceiling (clip-in)

暗架式方板吊顶标准规格表

Production Specifications 生产规格	Base Thickness (mm) 底板厚度	Per square meter comes with accessories 每平方米附送配件	Production Specifications 生产规格	Base Thickness (mm) 底板厚度	Per square meter comes with accessories 每平方米附送配件
300×1200	0.6-1.0	三角龙骨3.3米, 吊件4个, 接件0.6个 Triangle keel:3.3m, hanging parts:4, connecting parts:0.6	400×400	0.45-0.7	三角龙骨2.5米, 吊件3个, 接件0.6个 Triangle keel:2.5m, hanging parts:3, connecting parts:0.6
300×300	0.5	三角龙骨3.3米, 吊件4个, 接件0.6个 Triangle keel:3.3m, hanging parts:4, connecting parts:0.6	500×500	0.45-0.7	三角龙骨2米, 吊件3个, 接件0.6个 Triangle keel:2m, hanging parts:3, connecting parts:0.6
300×450	0.4-0.6	三角龙骨3.3米, 吊件4个, 接件0.6个 Triangle keel:3.3m, hanging parts:4, connecting parts:0.6	600×600	0.45-0.8	三角龙骨1.8米, 吊件2个, 接件0.4个 Triangle keel:1.8m, hanging parts:2, connecting parts:0.4
300×600	0.4-0.6	三角龙骨3.3米, 吊件4个, 接件0.6个 Triangle keel:3.3m, hanging parts:4, connecting parts:0.6	600×1200	0.6-1.0	三角龙骨1.8米, 吊件2个, 接件0.4个 Triangle keel:1.8m, hanging parts:2, connecting parts:0.4

Note: non-series products can be customized according to the actual production.
 备注: 非常规系列产品, 可根据实际需求定制生产。

SQUARE CEILING SERIES INVISIBLE FRAME TYPE (CLIP-IN)

暗架式方板吊顶系列



Invisible frame type square ceiling installation (clip-in)

暗架式方板吊顶安装

- 1 Installing the sideline in the same height.
- 2 Installing light steel main keel in appreciate space, the normal space is 1-1.2m, the hanging distance shall accord to the light steel main keel.
- 3 Binding the light steel main keel with the prepared hanging parts on the triangle keel, then clamp it under the light steel main keel in the vertical direction, the space of the triangle keel accords to the width of the plate. Then it is necessary to adjust it to plane after finishing installation.
- 4 Pressing the two parallel edges into the triangle keel slot, firstly installing one row of plate breadthwise and lengthways, make sure they are perpendicular, then installing the rest plates.
- 5 Pressing the square plates lightly, make sure the gap is perpendicular.
- 6 Wearing gloves when installing plate, if finger printers or stains remain on the plate, please remove it off with warm water and detergent, then dry it.

- 1 根据同一水平高度装好收边角;
- 2 按合适的间距吊装轻钢主龙骨, 一般间距是1-1.2米, 吊杆间距按轻钢主龙骨的规定分布;
- 3 把预装在三角龙骨的吊件连同三角龙骨紧贴轻钢主龙骨并与轻钢主龙骨成垂直方向扣在轻钢主龙骨下面, 三角龙骨间距按板宽规格而定, 全部装完后必须调整至水平;
- 4 将天花板的二条平行边轻压入三角龙骨的槽中, 先在横向和纵向的一边各装一排天花板, 然后确定互相垂直, 再把其余的天花板上;
- 5 方板与方板的拼接, 稍加压力便可达到紧凑的效果, 纵向与横向的板缝一定要垂直。
- 6 板面安装时必须带手套, 如不慎留下指印或污渍, 可用洗洁精开水清洗后抹干即可。

- | | |
|----------------------------------|--------|
| ① Hanging pole | 吊杆 |
| ② 38 main keel | 38主骨 |
| ③ Hanging parts of 38 main keel | 38主吊 |
| ④ Explosive bolt | 拉撑头 |
| ⑤ Triangle keel | 三角龙骨 |
| ⑥ Hanging parts of triangle keel | 三角龙骨吊件 |
| ⑦ Wall angle | 收边 |
| ⑧ Square plate | 方块板 |

XIANGSAI
China ceiling manufacturing
中国吊顶基地·广东制造 base in Guangdong

Accessories

配件

Big triangle keel series (applicable for any specifications of invisible frame type square plate)
大三角龙骨系列 (适用任何规格暗架式方块)

Big triangle keel
大三角龙骨



Aluminum gold (Galvanized iron available)
铝合金 (可镀锌铁板)



Standard Length 3m 标准长度 3米

Big triangle keel hanging parts
大三角龙骨吊件

Flexibly bent according to actual situation
可根据实际情况折弯



Aluminum gold (Galvanized iron available)
铝合金 (可镀锌铁板)

Big triangle keel connecting parts
大三角龙骨接件



Aluminum gold (Galvanized iron available)
铝合金 (可镀锌铁板)

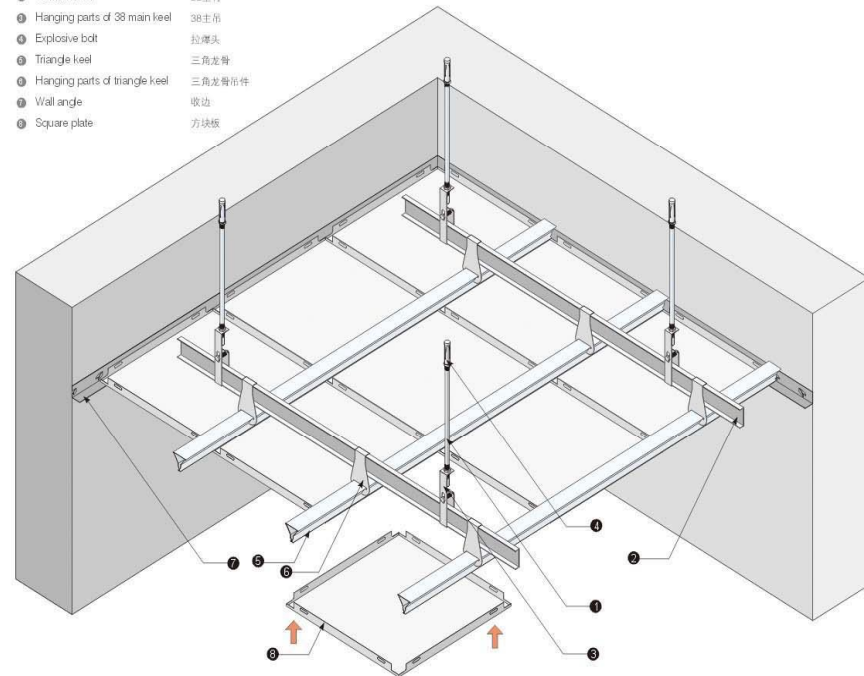

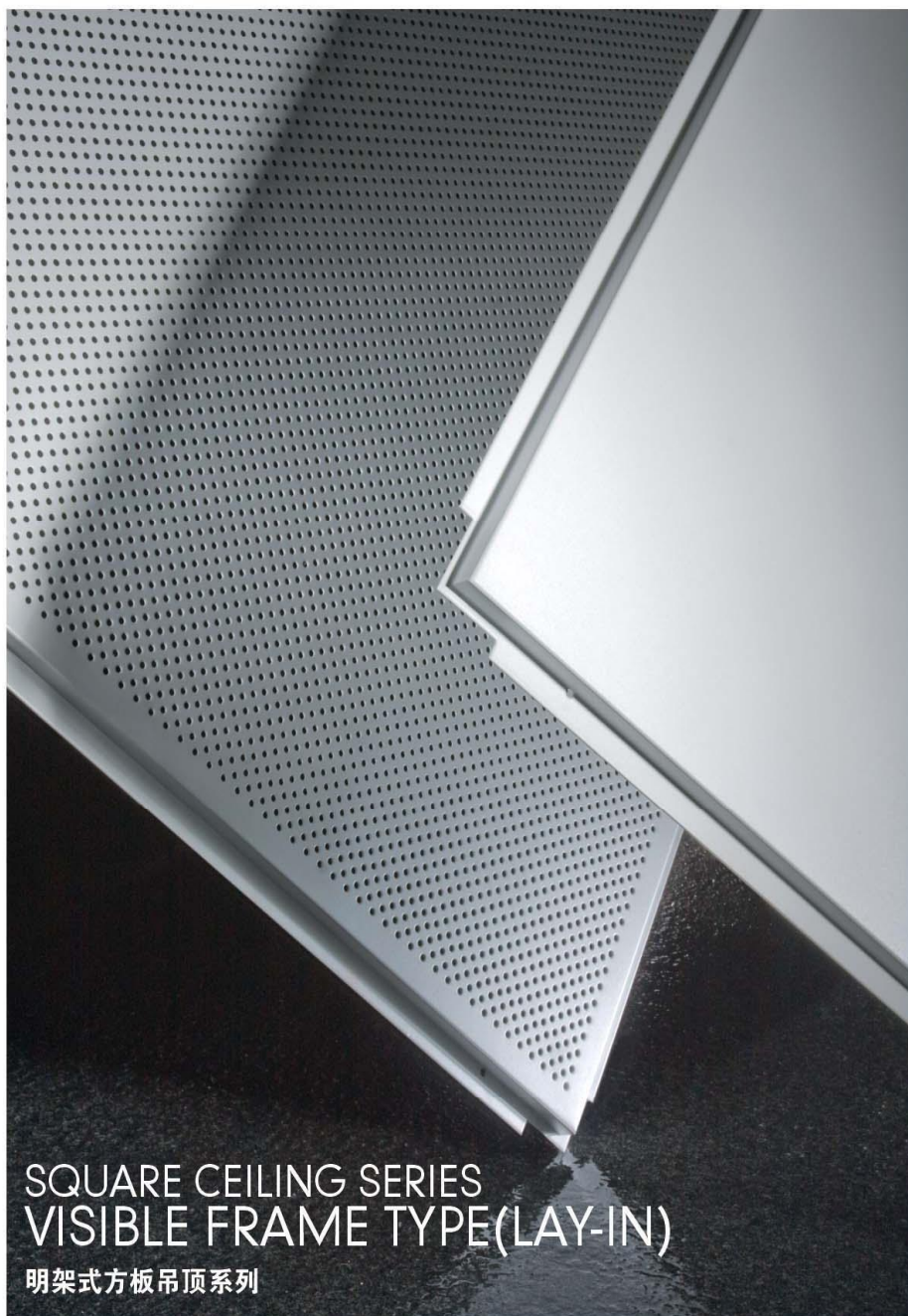

**SQUARE CEILING SERIES
 VISIBLE FRAME TYPE(LAY-IN)**
 明架式方板吊顶系列



Features Description

特点说明

visible frame type ceiling series(LAY-IN), because the installation of the framework and set out down-level style, has a unique visibility and powerful three-dimensional effect. Installation, the next frame the main bone of bone and vice port based on its reasonable shape, connections precise, stable, easy to install and the demolition of the foundation, visible frame keel lines clear and easy maintenance.

明架式方板吊顶系列，因其明置的安装框架和跌级款式，具有独特的可视性和超强的立体效果。安装中，明架主骨与副骨基于其合理的端口形状，连接精确，稳固，是安装与拆卸简便的基础。同时，明架式具备30多种冲孔花款可供选择，不仅可以起到美观装饰的效果，还能够通过吸音布起到消音降噪的实用功能。

Scope of application

适用范围

Applied to large area multi-projects, such as super-market, banks, hospitals, exhibition halls and other public places.

多应用于大面积的工程项目，如超级商场、银行、医院、展览馆等公共场所。

Visible frame type ceiling series(LAY-IN) standard table

明架式方板吊顶标准规格表

Production Specifications 生产规格	Base Thickness (mm) 底板厚度	Per square meter comes with accessories 每平方米附送配件
350 × 350	0.5	Per square meter of a distribution main keel, Vice keel 8 每平方米配送主龙骨一支、副龙骨8支
350 × 700	0.5	Main keel 1, Vice keel 4 主龙骨1支、副龙骨4支
595 × 595 (Fit for T24)	0.45-0.7	Distribution per square meter main keel 0.54, Vice keel 2.7, 0.2 income side 每平方米配送主龙骨0.54支、副龙骨2.7支，收边0.2支
595 × 595 (Fit for T15)	0.45-0.8	

Note: non-series products can be customized according to the actual production.
 备注：非常规系列产品，可根据实际要求定制生产。

SQUARE CEILING SERIES VISIBLE FRAME TYPE(LAY-IN)

明架式方板吊顶系列

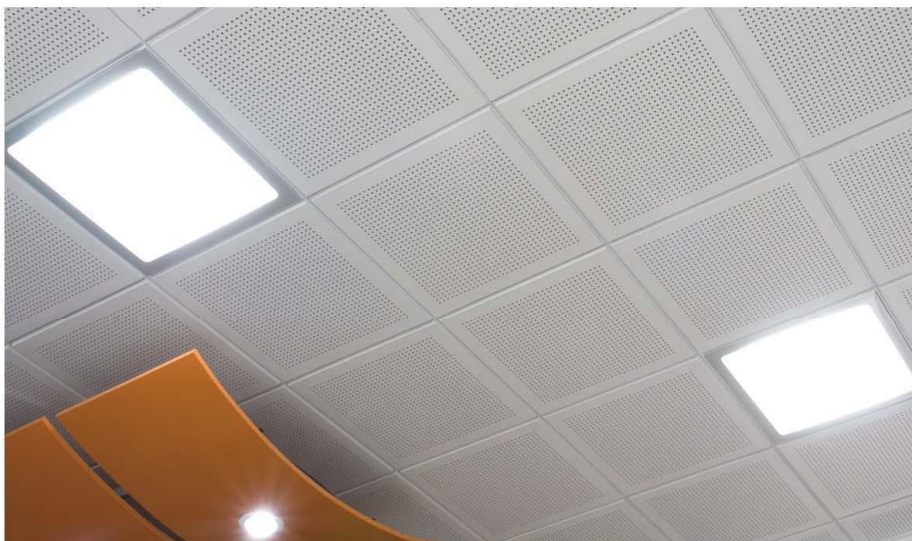

XIANGSAI
China ceiling manufacturing
中国吊顶基地 · 广东制造 base in Guangdong

Installation of visible frame stair type square ceiling(LAY-IN) (with round or square slot keel)

明架跌级式方板吊顶的安装 (配有圆槽或方槽龙骨)

- 1 Installing the sideline in the same height.
 - 2 Install the main keel with suspending rod and suspending parts.
 - 3 Inserting the sub keel into the main keel, adjusting to horizontal.
 - 4 Placing the ceiling plate into the square.
- 1 根据同一水平高度装好收边角;
2 将主龙骨用吊杆及吊件安装好;
3 将付龙骨插入主龙骨, 调好水平;
4 将天花板从龙骨上方放入方格内即可。

- ① Hanging pole 吊杆
- ② 38 main keel 38主骨
- ③ Hanging parts of 38 main keel 38主吊
- ④ Explosive bolt 拉爆头
- ⑤ Main runner Round slot keel 圆槽龙骨主骨
- ⑥ Cross runner Round slot keel 收边
- ⑦ Hanging parts of Visible frame keel 跌级板块
- ⑧ Wall angle 圆槽龙骨副骨
- ⑨ Stair plate 明架龙骨吊件

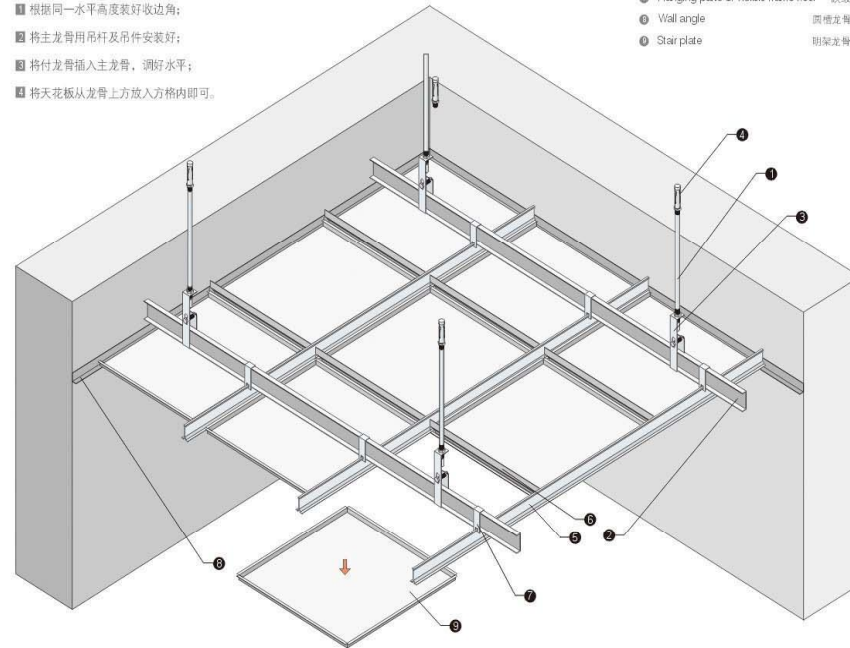

Installation modules: 602
安装模式: 602

Main keel 吊顶板块	Main keel 主龙骨	Auxiliary keel 副龙骨	Wall angle 收边
	 Round slot keel type 圆槽跌级式 Square slot keel type 方槽跌级式 T-Shaped horizontal keel T型平铺式	 Round slot keel type 圆槽跌级式 Square slot keel type 方槽跌级式 T-Shaped horizontal keel T型平铺式	 Round slot keel type 圆槽跌级式 Square slot keel type 方槽跌级式 T-Shaped horizontal keel T型平铺式
Visible keel No. 1 suspended part 明架龙骨 1号吊件 Flexibly bent according to actual situation 可按照实际需要任意弯曲	 Visible keel No. 2 suspended part 明架龙骨 2号吊件	Standard Length 3m 标准长度 3米 Every 1m equipped 1.02m 每平方米配 1.02米	Standard Length 0.6m 标准长度 0.6米 Every 1m equipped 1.62m 每平方米配 1.62米
	Standard Length 3m 标准长度 3米 Every 1m equipped 0.6m 每平方米配 0.6米	Standard Length 3m 标准长度 3米 Every 1m equipped 0.6m 每平方米配 0.6米	

Keel parts listed in the table are the recommended model:

Base material

基材

- Aluminum alloy, the grade of aluminum alloy can be selected according to the actual requirements.
铝合金, 可根据不同档次的要求选择铝合金的等级

Type of surface

表面类型

- Surface veneer: Powder coating (ordinary powder, polyester), rolling, laminating, metal anode oxidation treatment.
表面饰层: 喷涂 (普通粉末, 聚酯), 滚涂, 覆膜, 金属阳极氧化处理
- Can be pore plate or punching plate according to the actual requirements.
可根据实际需要选择无孔板或冲孔板

XIANGSAI

China ceiling manufacturing

中国吊顶基地·广东制造 base in Guangdong

STRIP SUSPENDED CEILING SERIES

条板(R扣、C扣)吊顶系列

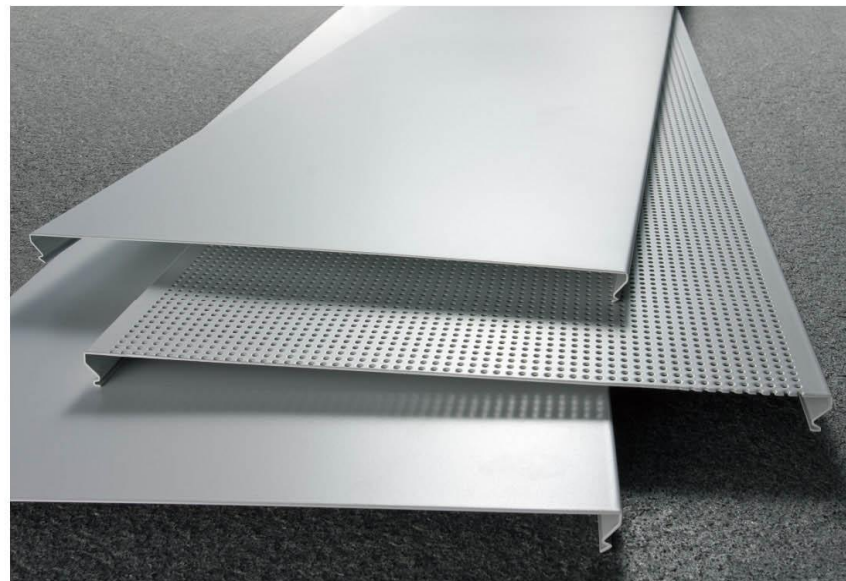

Features Description

特点说明

Features Description: strip ceiling can be divided into R-shaped ceiling and C-shaped ceiling. R-shaped ceiling usually highly hem design, usually use a thick substrate manufacture, fit the keel hook tooth shape, an increase of the overall structure of the solid ceiling degree. R buckle series rich colors, the installation structure, customers can choose whether to install according to their needs of inlay. Use of inlay, color rich, gorgeous; non-framed article from the whole is more condense and generous. Buckle series of colorful panels C, model diversity, more choices. Meanwhile, according to board and fit between the plates can be divided into: bevel type and the right type. Bevel type, between the board and board a V-grooves, decorative and strong; straight-edge type of fit is high, the overall stronger. Application areas: large-scale projects and various types of buildings, home environment can be used, is a highly modern decorative materials.

条板吊顶根据折边形状可分为R扣系列和C扣系列。

条板R扣系列通常采用高深折边的设计，通常选用较厚的基材制造，适配的龙骨勾齿形状，增加了吊顶的整体结构的牢固度。R扣系列色彩丰富，安装结构中，客户可根据自身需求选择是否安装锁条。选用锁条，色彩丰富，美轮美奂；不带锁条则整体更加简洁大方。

条板C扣系列色彩丰富、型号多样，更多选择。同时，根据板与板之间的契合度可分为：斜边类型和直边类型。斜边类型，板与板之间有一V型凹槽，装饰性强；直边类型则契合度高，整体性更强。

Scope of application

适用范围

larger public buildings, such as: airports, train stations, subway stations.
大面积的工程项目和各类建筑、家居环境均可采用，是一种现代感极强的装饰材料。

R-SHAPED CEILING SERIES

条板R扣吊顶系列

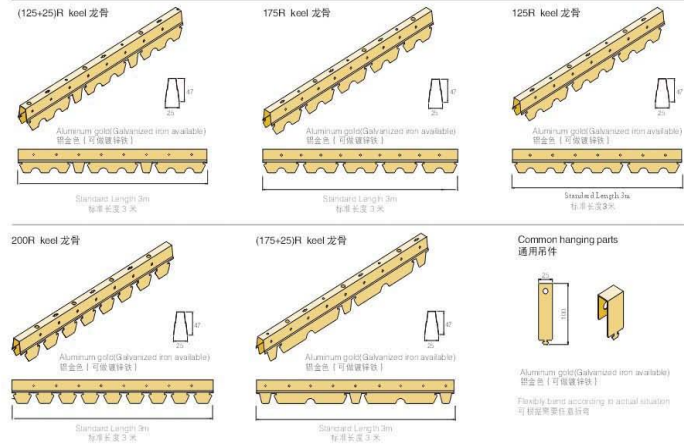

Table of R-shaped ceiling
条板R扣系列标准规格表

Production Specifications 规格名称	Base Thickness (mm) 厚度	Per square meter comes with accessories 每平方米附送配件
125R面	0.45-0.7	Keel 1 m 龙骨1米 Hanging 1 吊件1个
175面	0.5-0.65	
200面	0.7-0.8	

Note: non-series products can be customized according to the actual production.
备注：非常规系列产品，可根据实际需求定制生产。

Accessories 配件



XIANGSAI
China ceiling manufacturing
中国吊顶基地 · 广东制造 base in Guangdong

Installation of R-shaped ceiling (Method 1) R型吊顶的安装（方法一）

With upper suspending system, most standard installation method
带上层吊挂系统的安装，最规范的安装方法

- 1 Installing the sideline in the same height.
- 2 Lift the 38 main keel with hanging pole, explosive bolt and 38 main hanger.
- 3 Connect the R-shaped keel and the upper 38 main keel with common Hanging parts, adjust the whole hanging system to level.
- 4 Clamping the R-shaped strip ceiling with the R-shaped keel in order, installing color strips in the gap of two R-shaped plates.
- 5 Wearing gloves when installing plate, if finger printers or stains remain on the plate, please remove it off with warm water and detergent, then dry it.

- 1 根据同一水平和高度安装好收边角；
- 2 用吊杆、膨胀螺栓、38主吊把38主骨吊起；
- 3 用通用吊件把R型龙骨与上层的38主骨连接起来，把整个吊装系统调至水平；
- 4 将R型条扣天花板按顺序扣在R型龙骨上，在两条R型扣板间隙嵌入线条；
- 5 板面安装时必须带手套，如不慎留下指印或污渍，可用清洁剂开水清洗后抹干即可。

Installation of 125R with decorative bar 125R带锁条的安装（侧视图）

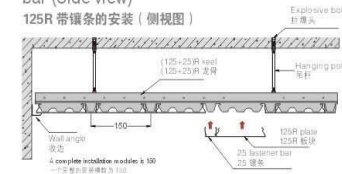

Installation of 200R -Shaped ceiling 200R型吊顶的安装（侧视图）

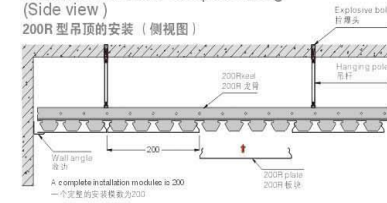

Installation parameters for R-shaped ceiling (mm) R型吊顶安装参数（mm）

- a < 300 Distance between hanging pole to the end of keel
吊杆至龙骨末端的间距
- b < 1700 Distance between hanging pole
吊杆之间的间距
- c < 1000 Distance between keels
龙骨之间的间距
- d < 500 Distance between keel to the end of plate
龙骨至板块末端的间距

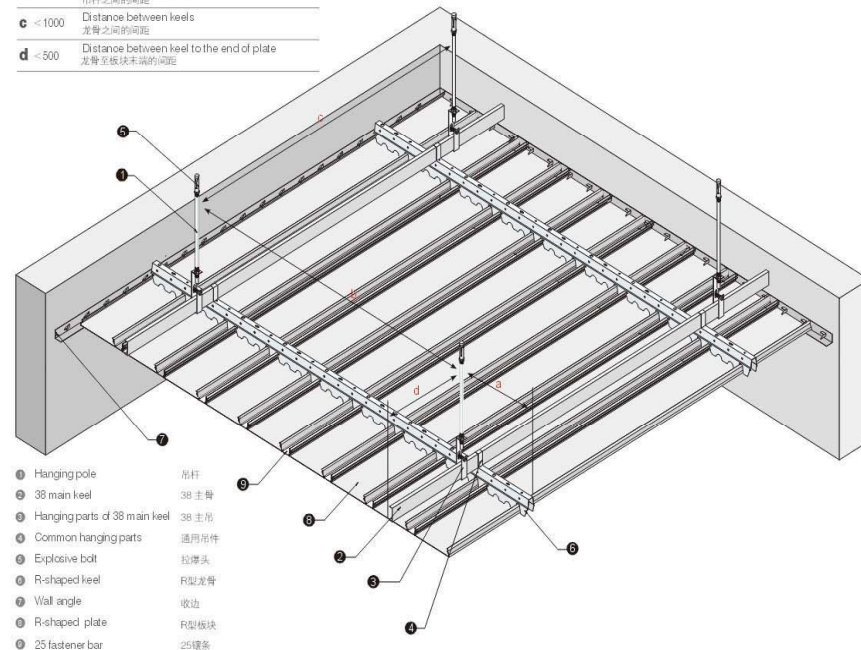

- 1 Hanging pole 吊杆
- 2 38 main keel 38主骨
- 3 Hanging parts of 38 main keel 38主吊
- 4 Common hanging parts 通用吊件
- 5 Explosive bolt 膨胀头
- 6 R-shaped keel R型龙骨
- 7 Wall angle 收边
- 8 R-shaped plate R型板块
- 9 25 fastener bar 25锁条

C-SHAPED CEILING SERIES

条板C扣吊顶系列

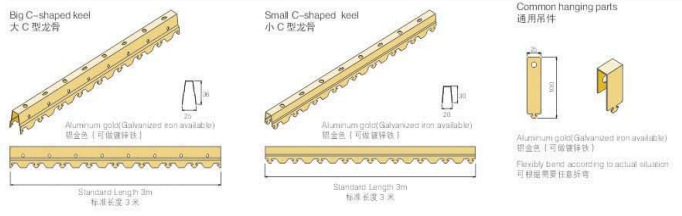

Table of C-shaped ceiling
条板C扣系列标准规格表

Production Specifications 规格名称	Base Thickness (mm) 厚度	Per square meter comes with accessories 每平方米附送配件
50面	0.4-0.6	Keel 1 m 龙骨1米 吊件1个
100面	0.4-0.65	
150面	0.4-0.65	
200面	0.45-0.65	
300面	0.55-0.8	

Note: non-series products can be customized according to the actual production.
备注: 非常规系列产品, 可根据实际需求定制生产。

Accessories 配件



XIANGSAI

China ceiling manufacturing

中国吊顶基地·广东制造 base in Guangdong

Installation of C-shaped ceiling (Method 1) C型吊顶的安装 (方法一)

With upper suspending system, most standard installation method
带上层悬挂系统的安装, 最规范的安装方法

- 1 Installing the sideline in the same height.
- 2 Lift the 38 main keel with hanging pole, explosive bolt and 38 main hanger.
- 3 Connect the C-shaped keel and the upper 38 main keel with common Hanging parts, adjust the whole hanging system to level.
- 4 Pressing the two parallel sides into the gap of the keel, make sure they are in Right angle, then installing other ceiling plates.
- 5 Wearing gloves when installing plate, it finger printers or stains remain On the plate, please remove it off with warm water and detergent, then dry it.

- 1 根据同一水平和高度安装好收边角;
- 2 用吊杆、膨胀螺栓、38主吊把38主骨吊起;
- 3 用通用吊件把C型龙骨与上层的38主骨连接起来, 把整个吊装系统调至水平;
- 4 将天花板的两条平行边压入龙骨的缝中, 确定互相垂直, 再把其余的天花板装上;
- 5 板面安装时必须带手套, 如不慎留下指印或污渍, 可用清洁剂开水清洗后抹干即可。

Installation parameters for C-shaped ceiling(mm) C型吊顶安装参数 (mm)

- a <300 Distance between hanging pole to the end of keel
吊杆至龙骨末端的间距
- b <1700 Distance between hanging pole
吊杆之间的间距
- c <1000 Distance between keels
龙骨之间的间距
- d <500 Distance between keel to the end of plate
龙骨至板末端的间距

Installation of C-shaped straight edge ceiling (side view) C型直边吊顶的安装 (侧视图)

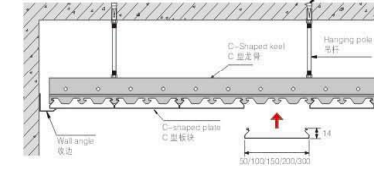

C-shaped plates with various widths can be installed on same keel
多种宽度的C型条板可在同一龙骨上有件安装

Installation of C-shaped bevel edge ceiling (side view) C型斜边吊顶的安装 (侧视图)

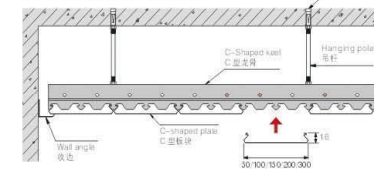

C-shaped plates with various widths can be installed on same keel
多种宽度的C型条板可在同一龙骨上有件安装

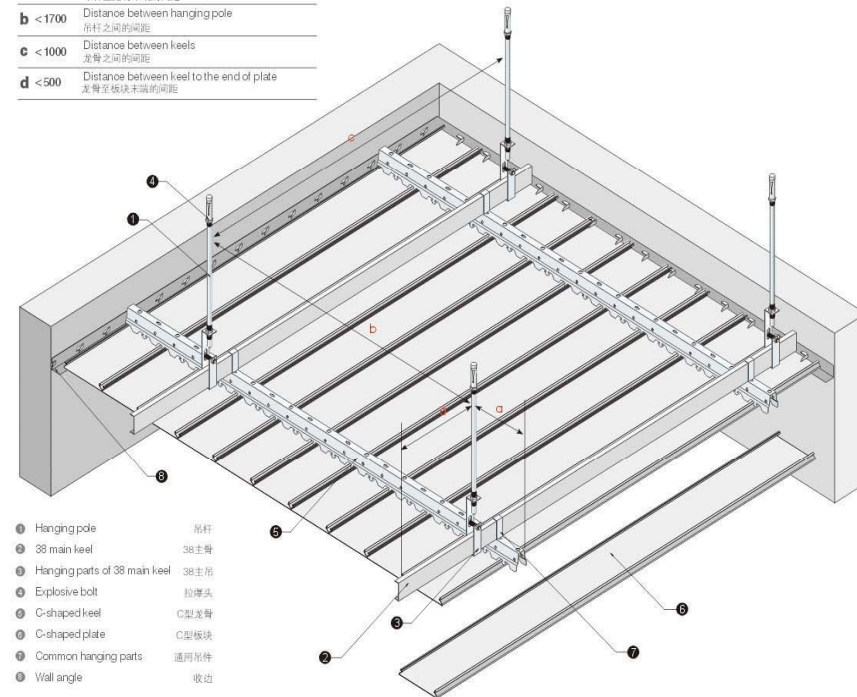

BOX CURTAIN

CEILING SERIES 方通吊顶系列



Features Description

特点说明

Box curtain ceiling is a new type of ceiling category. It can hide the pipeline and other similar facilities. It also can make the light sleek and soft with its flexible installation. And it shouldn't affect the installation of broadcast and fire protection system.

方通吊顶因其产品外形而得名，它能有效隐藏楼顶的管道和其他类似设施，同时混合照明灯具搭配，既能协调统一，又能柔和、均匀光线照明。方通吊顶拆装灵活，检修方便，同时也绝不影响房屋的吸音效果以及广播系统和消防花洒等设备的安装。

Scope of application

适用范围

多用于大面积的公共场所，如机场、火车站、地铁站等。
Large public buildings, such as: airports, train stations, subway stations.

Parameter of box curtain ceiling

盒式垂帘吊顶参数表

Height 高度	Width 宽度	Thickness 厚度	Length 长度	Legend 图例	Per square meter comes with accessories 每平方米附送配件
200	25	0.7-1.0	Customized 订尺		Keel 1 m 龙骨1米
150	25				
100	25				
200	30				
150	30				

Note: non-series products can be customized according to the actual production.
备注：非常规系列产品，可根据实际要求定制生产。

XIANGSAI
China ceiling manufacturing
中国吊顶基地·广东制造 base in Guangdong

Installation of box curtain suspended ceiling (method 1)

盒式方通吊顶的安装（方法一）

With upper suspending system, most standard installation method
带上层吊挂系统的安装，最规范的安装方法

- 1 Brush The facilities on the hanging pole into black
- 2 Lift the 38 main keel with hanging pole, explosive bolt and 38 main hanger
- 3 Connect the C-1 keel and the upper 38 main keel with C-1 hanger, adjust the whole hanging system to level
- 4 Fix the box curtain body onto the C-1 keel with bolts and caps

- 1 吊顶上方的设施先作刷黑处理
- 2 用吊杆，膨胀螺栓及38主吊把38主骨吊起
- 3 用C-1吊件把C-1龙骨与上层的38主骨连接起来，把整个吊装系统调至水平
- 4 用螺栓，螺帽把盒式垂帘体固定在C-1龙骨上

- ① Hanging pole 吊杆
- ② 38 main keel 38主骨
- ③ Hanging parts of 38 main keel 38主吊
- ④ Explosive bolt 拉爆头
- ⑤ Screw and nut 螺栓及螺帽
- ⑥ C-1 keel C-1龙骨
- ⑦ Hanging parts of C-1 keel C-1龙骨吊件
- ⑧ box curtain ceiling 盒式方通体
- ⑨ Shaping rod 龙形筋

Accessories 配件

C-2 keel the installation space is adjustable. The space of holes shall be confirmed according to the installation space.

C-2 龙骨
安装间距任意设定，打孔间距根据安装间距定

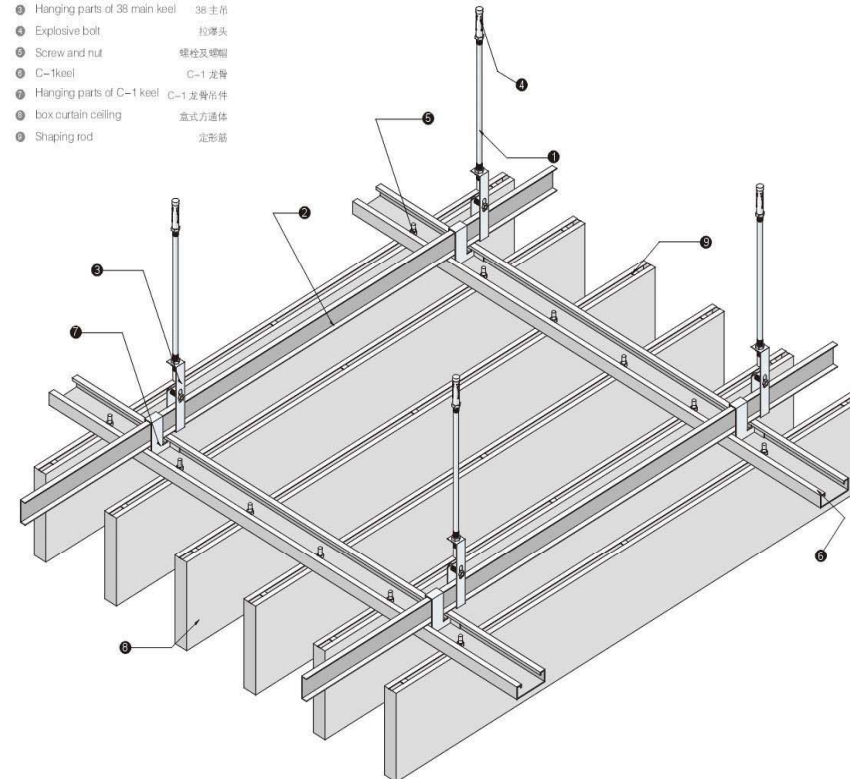
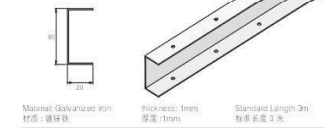

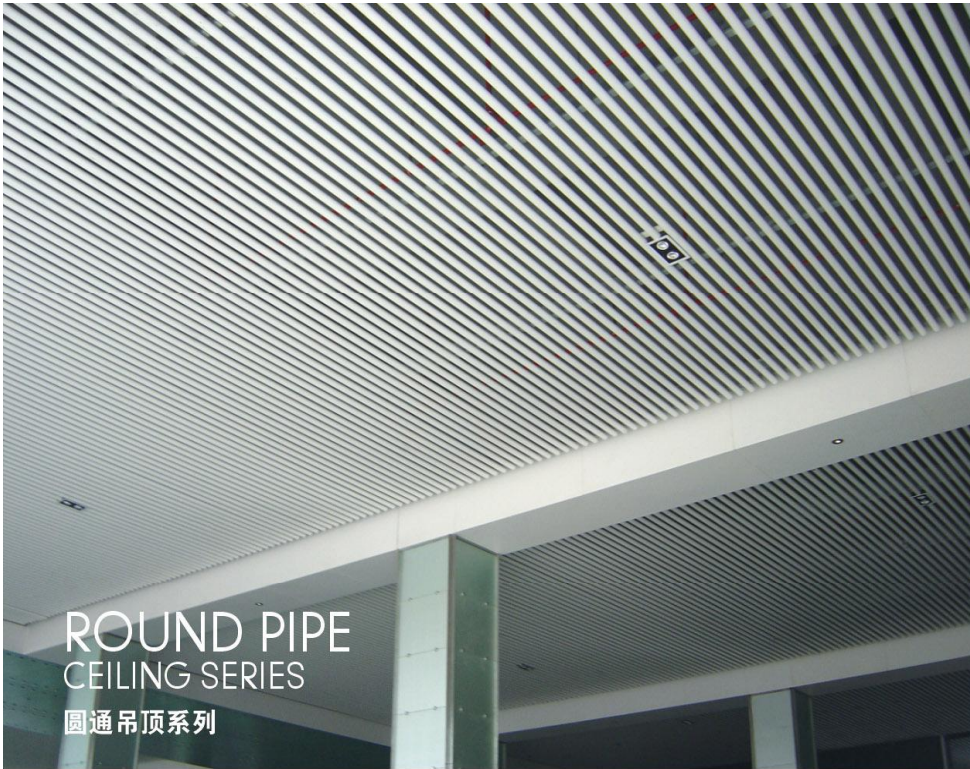

ROUND PIPE CEILING SERIES

圆通吊顶系列

Features Description 特点说明

Round pipe ceiling is a new type of ceiling category. More and more people begin to prefer to it, because of its soft and sleek appearance, open-style and free adjustable installation, and the flexible style.

圆管是近年来业界兴起的一种新型的吊顶品类，它以柔和、圆滑的外观、开敞式的安装风格、自由调节的安装间距、灵活多变的搭配形式受到越来越多客户的青睐。

Scope of application 适用范围

面积较大的公共建筑，如：机场、火车站、地铁站等。
large public buildings, such as: airports, train stations, subway stations.

Table of round pipe ceiling 圆通吊顶标准规格表

Height 高度	Slot width 槽宽	Diameter 管径	Thickness 厚度	Length 长度	Legend 图示	Per square meter comes with accessories 每平方米附送配件
57	14	50	0.8	常规生产长度6米以内		Keel 1 m 龙骨1米

Note: non-series products can be customized according to the actual production.
备注：非常规系列产品，可根据实际要求定制生产。



XIANGSAI
China ceiling manufacturing
中国吊顶基地·广东制造 base in Guangdong

Installation of Round Pipe Ceiling(Method 1) 圆管吊顶的安装(方法一)

- 1 Brush the facilities on the hanging pole into black
 - 2 Lift the 38 main keel with hanging pole, explosive bolt and 38 main hanger.
 - 3 Connect the C-1 keel and the upper 38 main keel with C-1 hanger, adjust the whole hanging system to level.
 - 4 Fix the round pipe body onto the C-1 keel with bolts and caps
- 1 吊顶上方的设施先作刷黑处理 2. 用吊杆，膨胀螺栓及 38 主吊把 38 主骨吊起
- 2 用 C-1 龙吊件把 C-1 龙骨与上层的 38 主骨连接起来，把整个吊装系统调至水平
- 3 用 C-1 龙吊件把 C-1 龙骨与上层的 38 主骨连接起来，把整个吊装系统调至水平
- 4 用螺栓，螺帽把圆管体固定在 C-1 龙骨上

- ① Hanging pole 吊杆
- ② 38 main keel 38 主骨
- ③ Hanging parts of 38 main keel 38 主吊
- ④ Explosive bolt 拉爆头
- ⑤ Bolt and nut 螺栓及螺帽
- ⑥ C-1 Keel C-1 龙骨
- ⑦ Hanging parts of C-1 Keel C-1 龙骨吊件
- ⑧ Round Pipe 圆管体
- ⑨ Side Cover 边盖

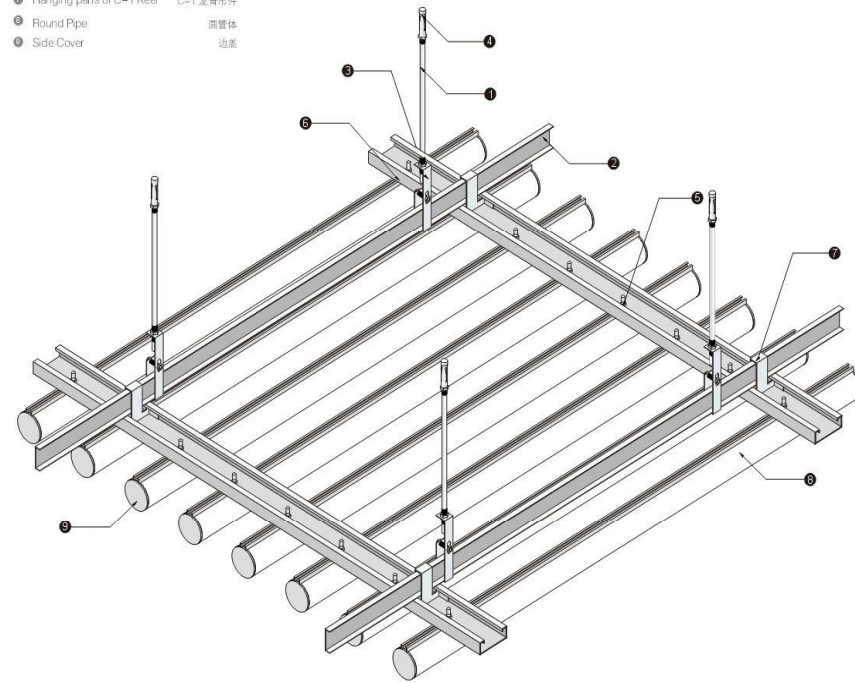

Accessories 配件

C-2 keel
The installation space is adjustable. The space of holes shall be confirmed according to the installation space.

C-2 龙骨
安装间距任意设定，
打孔间距根据安装间距定

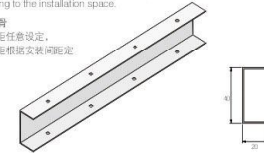

Material: Galvanized iron 材质: 镀锌铁
Thickness: 1mm 厚度: 1mm
Standard Length: 3m 标准长度: 3米

Side Cover
边盖



Material: Plastic 材质: 塑料

GRID CEILING SERIES

格栅吊顶系列

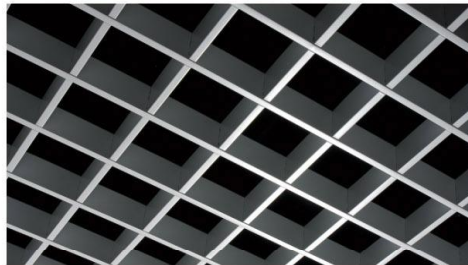

Features Description 特点说明

Grid ceiling is decorated ceilings of large places. It can effectively hide at the top of the pipe and other similar facilities, ventilation, decorative effect is extremely strong. The product after the installation is a Warren, structured, view effect continuous smooth, rich Super icing. Installation, according to actual demand on bone fish differing degrees of trim, and the main bone and bone structure of the port pair of diction, and also make bone of the link.

格栅吊顶是大面积场所天花装修的新宠。它可以有效的隐藏楼顶的管道和其他类似设施，通风好，装饰效果极强。其产品安装后纵横交错、层次分明，视角效果连续平整、富有超强的立体感。安装中，可根据实际需求对骨条做不同程度的修剪，而主骨和副骨的端口构造考究，也使得骨条的链接天衣无缝。

Scope of application 适用范围

大面积的公共场所，如火车站、机场等。
larger public buildings, such as: airports, train stations, subway stations.

Dark Ceiling Rack box standard table 格栅吊顶标准规格表

Height 高度	Width 宽度	Thickness 厚度	Per square meter comes with accessories 每平方米附送配件
36	10	0.3-0.5	Hanging 1 吊件1个
38	10	0.3-0.5	
43	10	0.3-0.5	
48	10	0.3-0.5	

Note: non-series products can be customized according to the actual production.
备注：非常规系列产品，可根据实际要求定制生产。

Parameters of grid materials 格栅平方用料表

Specification 规格	Length (mm/each) 长度 (毫米/支)	M/m ² 米/平方	Each/m ² 支/平方	Suspending Parts/m ² 吊件/平方	Accessories 配件
50x50	2000	40	20	1	Hanging parts of grid ceiling 格栅吊件 
75x75	1950	26.667	13.68	1	
100x100	2000	20	10	1	
150x150	1950	13.333	6.84	1	
200x200	2000	10	5	1	

XIANGSAI

China ceiling manufacturing

中国吊顶基地·广东制造 base in Guangdong

Installation of grid ceiling 格栅吊顶的安装

- 1 Install the grid ceiling on the floor;
- 2 Lift the prepared ceiling with suspending parts, rod, expansion bolts and nut;
- 3 Adjusting to plane after connecting the entire ceiling

- 1 将格栅天花在地上预装好;
- 2 用吊件、吊杆、螺帽、膨胀螺栓，把预装好的格栅天花吊起;
- 3 将格栅天花连接后，调整至水平即可。

- ① Hanging pole 吊杆
- ② Explosive bolt 拉爆头
- ③ Hanging parts of grid ceiling 格栅专用吊件
- ④ Main keels 主骨
- ⑤ Auxiliary keels 副骨

Side elevation of main and auxiliary keel of grid suspended ceiling 格栅吊顶主副骨组拼侧视图

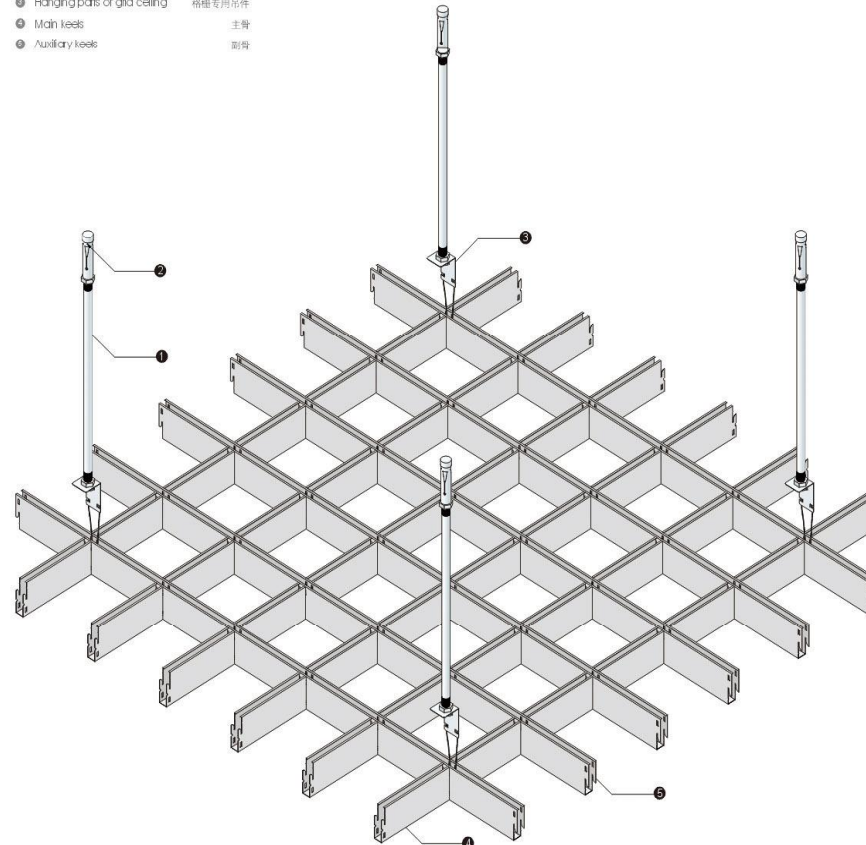
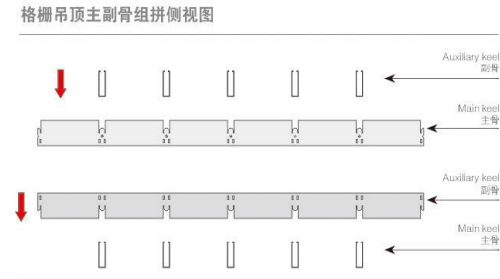

SLICE CURTAIN CEILING SERIES 垂帘吊顶系列

XIANGSAI
China ceiling manufacturing
中国吊顶基地·广东制造 base in Guangdong

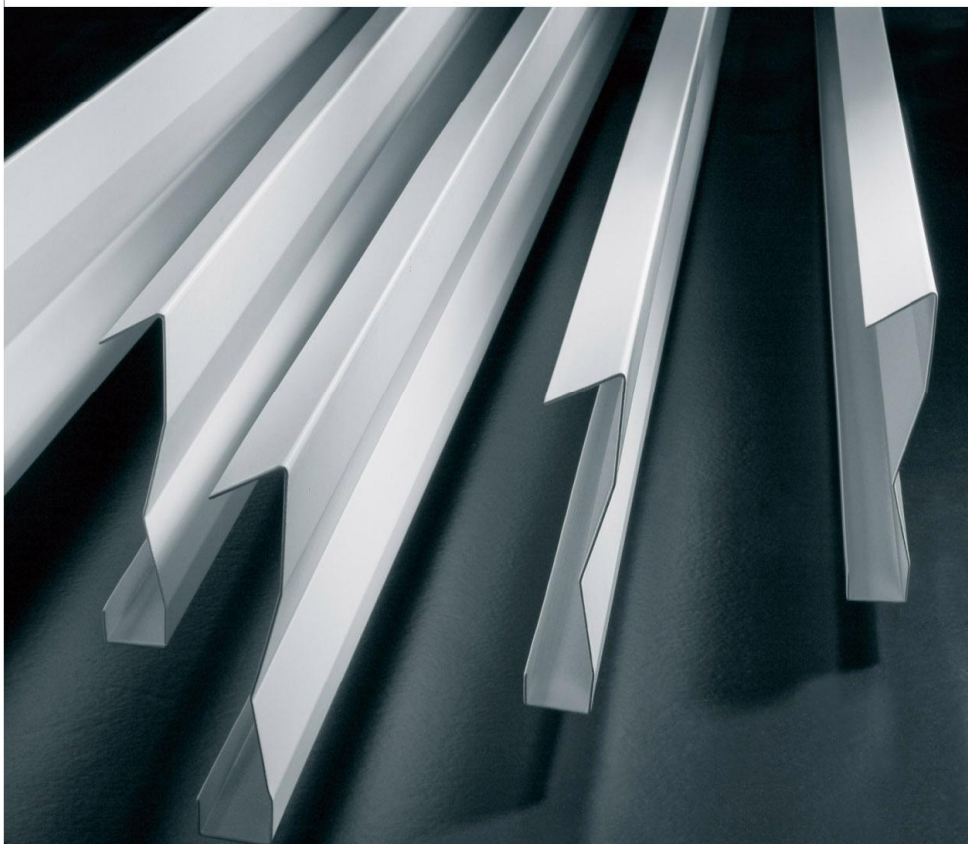

Slice Curtain Description

特点说明

Drape ceiling is a kind of visibility into the sky-ceiling, are free to adjust the height of the housing, effectively hiding from the roof of the pipeline and other similar facilities while mixed lighting, both the harmonization and unification, and soft, uniform light lighting. Drape ceiling Assembly and disassembly of the flexible, easy maintenance, but also affect housing sound and broadcast systems and devices such as fire sprinkler installation.

垂帘吊顶是一种可视性天幕型吊顶,可自由调节房屋视角高度,有效隐藏楼顶的管道和其他类似设施,同时混合照明灯具搭配,既能协调统一,又能柔和、均匀光线照明。垂帘吊顶拆装灵活,检修方便,同时也绝不影响房屋的吸音效果以及广播系统和消防花洒等设备的安装。

Scope of application

适用范围

多用于大面积的公共场所,如车库、大型走廊、机场、地铁站等。

Used for large areas of public places, such as a garage, large corridor, airport, Metro stations, etc.

Table of slice curtain ceiling

垂帘吊顶标准规格表

Model 规格型号	Height:mm 高度	Thickness:mm 厚度 (mm)	Length:m 长度 (米)	Per square meter comes with accessories 每平方米附送配件
4-Pieces 4刀	100面	0.5	Within 4 m 4米以内	Keel 1 m 龙骨1米 吊件1个
	150面	0.5-0.65		
	200面	0.5-0.65		
6-Pieces 6刀	100面	0.5-0.65	Maximum length 6m 常规生产长度6米以内	Keel 1 m 龙骨1米 吊件1个
	150面	0.4-0.65	Within 4 m 4米以内	
	200面	0.5-0.65		

Note: non-series products can be customized according to the actual production.

备注: 非常规系列产品,可根据实际要求定制生产。

SLICE CURTAIN CEILING SERIES

垂帘吊顶系列

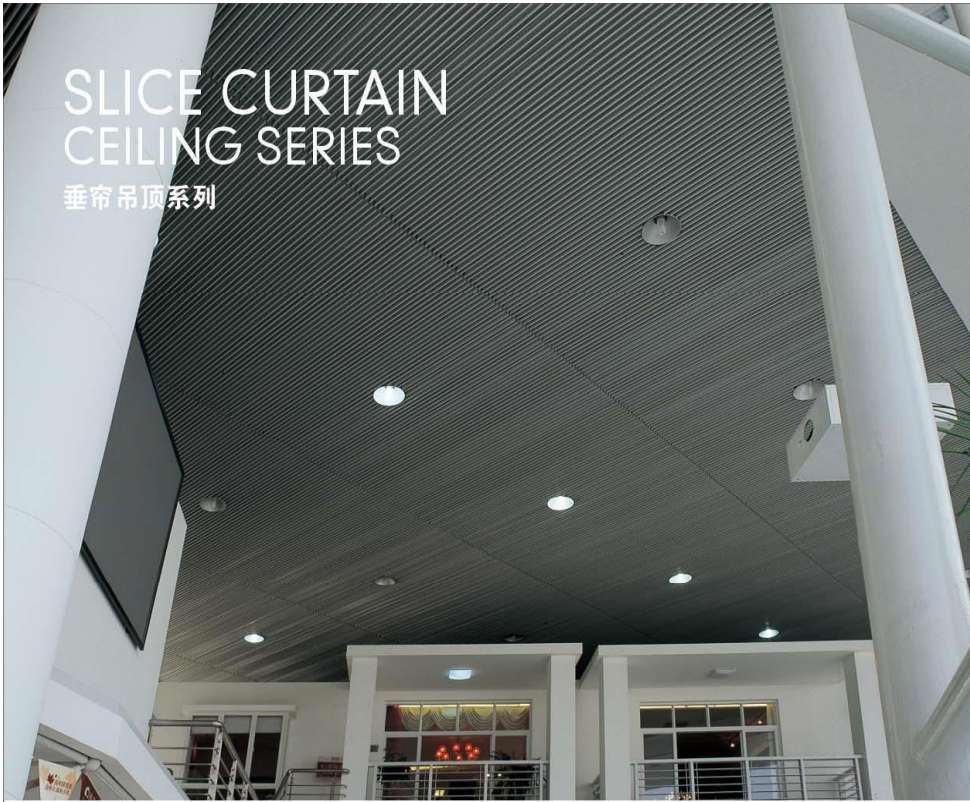

XIANGSAI
China ceiling manufacturing
中国吊顶基地·广东制造 base in Guangdong

Installation of Slice Curtain Ceiling 垂帘吊顶安装

With upper suspending system, most standard installation method
带上层吊挂系统的安装, 最规范的安装方法

- As the open ceiling, it is necessary to brush the internal of the ceiling into black.
- Lift the 38 main keel with hanging pole, explosive bolt and 38 main hanger.
- Connect the curtain keel and the upper 38 main keel with common hanging parts, adjust the whole hanging system to level.
- Jam the curtain panel into the gap of the keels.

- 由于该吊顶是开放式吊顶, 一般吊顶内部先需要作刷黑处理
- 用吊杆, 膨胀螺栓及38主吊把38主骨吊起
- 用通用吊件把垂帘龙骨与38主骨连接起来, 把整个吊装系统调至水平
- 将垂帘板块卡在龙骨缺口上

Accessories 配件

Curtain Keel 垂帘龙骨

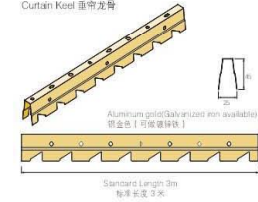

Common hanging parts 通用吊件



- ① Hanging pole 吊杆
- ② 38 main keel 38主骨
- ③ Hanging parts of 38 main 38主吊
- ④ Explosive bolt 拉爆头
- ⑤ Common hanging parts 通用吊件
- ⑥ Curtain keel 垂帘龙骨
- ⑦ Curtain panel 垂帘板块

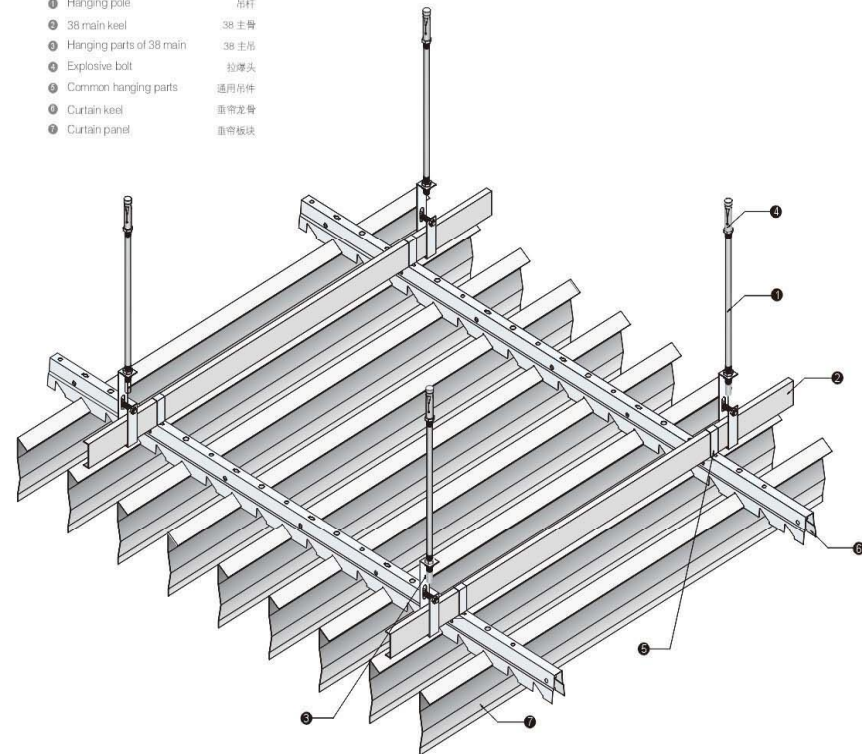

Installation parameters for 6-pieces curtain(mm) 6刀垂帘吊顶安装参数(mm)

Three kinds of common heights
常规高度三种

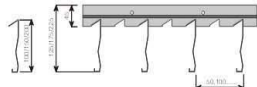

Height is customized according to client's requirements
高度可根据客户的要求定制

Installation space: 50, 100 ... which shall be the multiple of 50
安装间距: 50, 100 ... 50的倍数

Installation of 6-pieces curtain (side view) 6刀垂帘的安装 (侧视图)

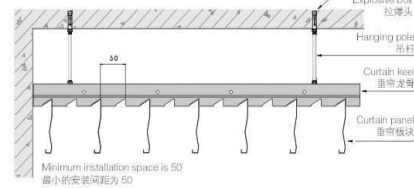

Installation parameters for 4-pieces curtain(mm) 4刀垂帘吊顶安装参数(mm)

Three kinds of common heights
常规高度三种

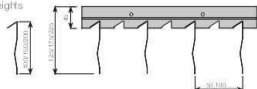

Height is customized according to client's requirements
高度可根据客户的要求定制

Installation space: 50, 100 ... which shall be the multiple of 50
安装间距: 50, 100 ... 50的倍数

Installation of 4-pieces curtain (side view) 4刀垂帘的安装 (侧视图)

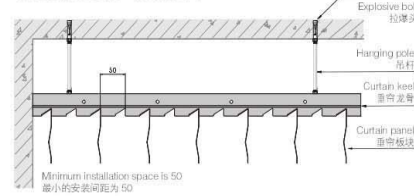

WALL ANGLE SERIES 收边角系列

Upper suspending system is widely applied for the installation of various suspended ceilings
上层悬挂系统，广泛应用于各类型吊顶的安装。

The parts of upper suspended system are light steel keel products, the parts are not listed in the accessories of standard list of ceiling manufacturer.

上层悬挂系统的组成部件，属轻钢龙骨系列产品，不在吊顶厂家按标准配比附送的配件范围内。

Parts of upper suspending system 上层悬挂系统的组成部件

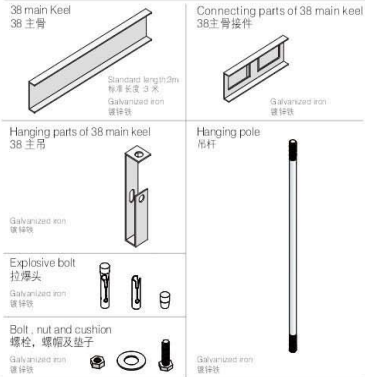

The parts listed in the table are the recommended models. There are more parts which may be used for upper suspended systems and not completely listed out here. 表格内所列的部件，是推荐使用的型号，可用于上层悬挂系统的部件还有很多，本图未一一列出。

Connection for 38 main keel 38 主骨的接驳

- 38 main keel 38 主骨
- Connecting parts of 38 main keel 38 主骨接件

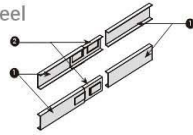

Upper suspending system can be constructed into "cross" structure with various suspended ceiling keel and can assure the levelness of whole suspending system with more solid structure.

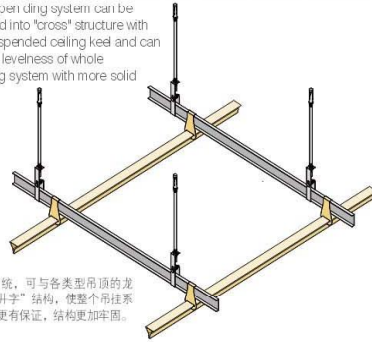

上层悬挂系统，可与各类型吊顶的龙骨，组成“井字”结构，使整个悬挂系统的水平度更有保证，结构更加牢固。



Connection of upper suspending system with C-shaped keel
上层悬挂系统与 C 型龙骨的连接

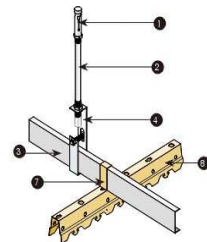

Connection of upper suspending system with triangle keel
上层悬挂系统与三角龙骨的连接

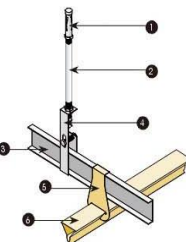

Connection of upper suspending system with C-1 keel
上层悬挂系统与 C-1 龙骨的连接

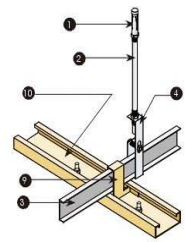

- Explosive bolt 拉爆头
- Hanging pole 吊杆
- 38 main keel 38 主骨
- Hanging parts of 38 main keel 38 主骨吊件
- Hanging parts of triangle keel 三角龙骨吊件
- Triangle keel 三角龙骨
- Common hanging parts 通用吊杆
- C-shaped keel C 型龙骨
- Hanging parts of C-1 keel C-1 吊件
- C-1 keel C-1 龙骨

23*23 L-punching wall angle
23*23 L 型冲孔边角

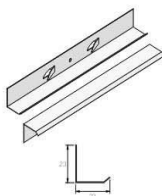

25*25 right angle wall angle
25*25 直角边角

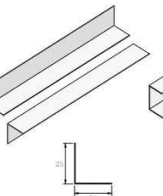

G-shaped wall angle
G 型边角

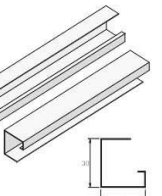

25*18 wooden wall angle
25*18 木线边角

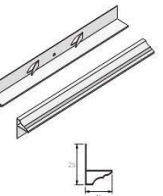

Edge seaming round wall angle
圆边圆型边角

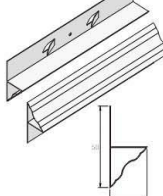

ENGINEERING 工程灯具 LAMP

Flat Light Source Features 光源性能

- Tube chosen king of the reputation of Chinese light new T5 lighting Foshan original three-color tube, color performance is good, soft light, does not damage the eyes.
- Saving and environmental protection. Designed series of low temperature is, and the photoelectric conversion rate of 80%, 60% higher than incandescent lamps.
- Long service life is 3-4 times the normal service life of fluorescent lamps. Done in the lighting lamp on the metal guard ring design specifically to prevent the tube ends black. Meanwhile, the use of three spiral electrode, to ensure that the electronic bombardment of phosphor emission enough to make a higher brightness and longer life.
- 灯管选用了有中国灯王美誉的佛山照明新型的 T5 原三色灯管，显色性能好，光线柔和，不伤眼睛。
- 节能环保。温度低属冷光系列，且光电转换率达 80%，高出白炽灯 60%。
- 使用寿命长，是普通荧光管使用寿命的 3-4 倍。在照明灯管上做了专门的金属保护环设计，防止灯管两端发黑。同时，采用的三螺旋电极，确保能够发射足够的电子轰击荧光粉，使亮度更高，寿命更长。



Electronic Ballast 电子镇流器

- Ballast with high-quality brushed aluminum exterior, beautiful, and more good thermal performance and fire resistance.
- After all the ballast fluorescent tubes parameters were tested, tailored made.
- Moisture-proof performance, and additional exception to protect the circuit, greatly extending its life. Up to 95% power factor, harmonic interference is almost negligible.
- 镇流器外部采用优质的拉丝铝，美观大方，且更具有良好的散热性能与防火性能。
- 所有镇流器均经过光管参数测试后，量身定做而成。
- 防潮性能优异，并加设异常保护电路，大大延长其使用寿命。功率因数高达 95% 以上，谐波干扰几乎可以忽略。



Specifications Model 规格型号



Z1200-10
Function: Lighting
Spec: 600mm x 1200mm
Power: 90W
For pannel-type: square pannel

功能：照明
标准生产尺寸：600mm x 1200mm
功率：90W
适用板型：方板



Z600-5
Function: Lighting
Spec: 600mm x 600mm
Power: 144W
For pannel-type: square pannel

功能：照明
标准生产尺寸：600mm x 600mm
功率：144W
适用板型：方板